

---

**PLEASE RETAIN**



# **Solis F500 Curve**



## **INSTALLATION AND OPERATING INSTRUCTIONS**

*This appliance is hot while in operation and retains its heat for a long period of time after use. Children, aged or infirm persons should be supervised at all times and should not be allowed to touch the hot working surfaces while in use or until the appliance has thoroughly cooled.*

*When using the stove in situations where children, aged and/or infirm persons are present a fireguard must be used to prevent accidental contact with the stove. The fireguard should be manufactured in accordance with BS 8423:2010.*

---

---

## TABLE OF CONTENTS

	<b>PAGE NO.</b>
1. Stanley Stove Warranty . . . . .	2
2. Installation Checklist . . . . .	3
3. Important Operation/ Maintenance Notes . . . . .	4
4. Installation & Operating Instructions . . . . .	5
5. General . . . . .	5
6. Flues . . . . .	5
7. Chimney . . . . .	5
8. Flue Exit (Top and Rear) . . . . .	6
9. Down Draughts . . . . .	7
10. Ventilation & Combustion Air Requirements . . . . .	7
11. External Ducted Air . . . . .	8
12. Heat Recovery Ventilation (HRV) . . . . .	9
13. Location . . . . .	9
14. Clearance To Combustibles . . . . .	9
15. Floor Protection . . . . .	9
16. Stove Dimensions . . . . .	10
17. Commissioning and Handover . . . . .	10
18. Operation . . . . .	10
19. Air Controls . . . . .	10
20. Recommended Fuels . . . . .	11
21. Technical Data . . . . .	11
22. Lighting . . . . .	11
23. Installing Solid Fuel Kit . . . . .	12
24. Lighting The Stove . . . . .	12
25. Refuelling . . . . .	13
26. Slow Burning . . . . .	13
27. Disposal of Ashes . . . . .	13
28. Monthly Maintenance . . . . .	13
29. Periodic Maintenance . . . . .	13
30. Chimney Cleaning . . . . .	13
31. Glass Cleaning . . . . .	13
32. Cleaning a Matt Black/ Senotherm Stove . . . . .	13
33. Prolonged Periods of Non Use . . . . .	14
34. Fire Safety . . . . .	14
35. Glass Replacement . . . . .	14
36. CO Alarm . . . . .	14
37. Exploded View . . . . .	15



## STANLEY STOVE WARRANTY

### CONDITIONS OF WARRANTY

Your Stanley Stove is guaranteed against any part that fails (under normal operating conditions) as detailed in the following table with timelines specified from the date of installation of the appliance. If the unit is not installed within six months of date of purchase, the warranty will commence six months from the date of purchase.

Warranty Period	Parts Covered (Parts & Labour unless Stated)
Up to 1 Year	<ul style="list-style-type: none"><li>• Refractory materials (supply only)</li><li>• Rope seals, glass seals and cement seals.</li><li>• Surface Finish on Seno models.</li><li>• Grates and fire bars.</li><li>• Ceramic glass is covered for Thermal breakage (supply only).</li><li>• Rust (if reported before installation)</li><li>• Aesthetic Damage (provided reported on date of receipt)</li></ul>
Up to 5 Years	<ul style="list-style-type: none"><li>• All external castings (excluding impact damage or damage caused by overfiring). Pictures of damage must be submitted to WS Service Department.</li></ul>

All warranty claims must be reported to the Waterford Stanley Service Department and must be submitted with the product serial number (located on the back of the fire door), date of purchase, proof of purchase (if requested) and details of the specific nature of the problem.

The warranty is given only to the original consumer/purchaser only and is non-transferable. The appliance must be installed by a suitable qualified person and installed as per the requirements of the manual. Failure to comply with the Installation Requirements or Building Regulations will void your warranty. Waterford Stanley reserve the right to replace any part due to manufacturing defect that fails within the warranty period under the terms of the warranty. The unit must be used for normal domestic purposes only and in accordance with manufacturer's operation instructions.

### LIMITS OF LIABILITY

The warranty does not cover:

- \* Special, incidental or consequential damages, injury to persons or property, or any other consequential loss.
- \* Any issue caused by negligence, misuse, abuse or circumstances beyond Waterford Stanley's control.
- \* Any issue with wear and tear, modification, alteration, or servicing by anyone other than an authorized service engineer.
- \* Installation and operational related problems such as draught related issues external to the stove, inadequate venting or ventilation, excessive flue offsets, negative air pressure caused by insufficient burning of improper fuel.
- \* Damage caused to the unit while in transit.
- \* Discolouration due to over firing, damage caused by impact, damage to baffles caused by over firing and fading of surface finish on castings.
- \* Stress fractures on bricks.
- \* Rust on cast iron parts unless reported prior to unit being installed.
- \* Aesthetic damage, rust & missing parts on units purchased off display.

**Note:** Adequate clearance must be maintained around the appliance to ensure the ease of part removal in the possible event of their damage/failure. Waterford Stanley are not responsible for any costs incurred in the removal of items installed in the vicinity of the appliance that have to be moved to facilitate a part replacement.

## INSTALLATION CHECK LIST

Tick

### *Flue System*

1. Minimum Flue Height of 4.6 metres (15 feet).
2. Appliance should be connected to a minimum of 1.8 metres (6 feet) of 150mm (6") flue pipe.
3. The horizontal flue run should not exceed 150mm (6")
4. All flue pipework passing through walls must be sleeved & adequately insulated in line with current Building Regulations.
5. Appliance should be connected to a chimney of less than 200mm (8") in diameter (otherwise the chimney must be lined with a 6" flue liner).
6. The chimney/ flue termination must be located in accordance with building regulations part J.
7. The chimney serving this appliance should not serve any other appliance.
8. Access should be provided to the chimney serving the appliance to allow for cleaning.
9. It is a requirement by Building Regulations to have a carbon monoxide alarm fitted to any room with a solid fuel appliance.

### *Location*

10. Clearance to combustible materials must be adhered to as described in the Clearance to Combustible section.
11. The stove must be installed on a floor protector that covers the area under the stove and extends 225mm to the front, 200mm to the sides and back.
12. Clearance must be maintained to allow for maintenance and part replacement.

### *Ventilation & Combustion Air Requirements*

13. The room in which the appliance is located should have an air vent of adequate size to support correct combustion (see Ventilation & Combustion Air Requirement Section for specific details).
14. The stove must not be installed in the same room as an extractor fan.



---

## IMPORTANT OPERATION / MAINTENANCE NOTES

Now that your Stanley Stove is installed and no doubt you are looking forward to the many comforts it will provide, we would like to give you some tips on how to get the best results from your stove.

1. We would like if you could take some time to read the operating instructions/hints, which we are confident, will be of great benefit to you.
2. Do not burn fuel with a high moisture content, such as a damp peat or unseasoned timber. This will only result in a build up of tar in the stove and in the chimney.

<b>FUEL CALORIFIC VALUES - SOLID FUELS</b>		
Anthracite 25-50mm	C.V.: 8.2kW/Kg	14,000 BTUs/lb
House Coal 25-75mm	C.V.: 7.2kW/Kg	12,000 BTUs/lb
Timber - Firebox size	C.V.: 5.0kW/Kg	8,600 BTUs/lb
Peat Briquettes	C.V.: 4.8kW/Kg	8,300 BTUs/lb

3. **IMPORTANT:** The first few fires should be relatively small to permit the refractory to set properly and season the stove. During these firings it is recommended to ventilate the room as an unpleasant (not toxic) odour may be emitted as the paint is completing curement.

**LEAVE THE DOOR SLIGHTLY AJAR DURING THE FIRST FIRING TO PREVENT THE ROPE FROM STICKING TO THE PAINT DURING THE CURING PROCESS.**

4. **Inspect the flue-ways of the stove weekly and ensure that there are no blockages. Check flue ways before lighting especially after a shut down period. Please see chimney cleaning section.**
5. Never allow a build up of ashes in the ash pan, as this will cause the grate to burn out prematurely. Empty the ashpan when refuelling.
6. Avoid slow burning of damp or unseasoned fuel as this will result in tarring flue ways and chimney i.e. peat or timber.
7. Allow adequate air ventilation to ensure plenty of air for combustion.
8. Do not burn rubbish/household plastic.
9. Clean the chimney at least twice a year.
10. Burning soft fuels such as timber and peat will stain the glass. Regular cleaning will prevent permanent staining. Clean with soapy water when cool.
11. Keep all combustible materials a safe distance away from unit, please see section for clearances to combustibles.
12. Never use aerosol spray near the appliance when it is in operation.
13. For safety reasons never leave children or the elderly unaccompanied while stove is in use. Use a fire guard.
14. Avoid contact with the appliance when in use as stove reaches very high operating temperatures.
15. This appliance should be regularly maintained by a competent service engineer.

## INSTALLATION & OPERATING INSTRUCTIONS

### GENERAL

When installing, operating and maintaining your Stanley Stove respect basic standards of fire safety. Read these instructions carefully before commencing the installation. Failure to do so may result in damage to persons and property. Consult your local Municipal office and your insurance representative to determine what regulations are in force. Save these instructions for future reference.

Please note that it is a legal requirement under England & Wales Building Regulations that the installation of the stove is either carried out under Local Authority Building Control approval or is installed by a Competent Person registered with a Government approved Competent Persons Scheme. HETAS Ltd operate such a scheme and a listing of their Registered Competent Persons can be found on their website at [www.hetas.co.uk](http://www.hetas.co.uk).

Special care must be taken when installing the stove such that the requirements of the Health & Safety at Work Act are met.

#### **Handling**

Adequate facilities must be available for loading, unloading and site handling.

#### **Fire Cement**

Some types of fire cement are caustic and should not be allowed to come into contact with the skin. In case of contact with the skin wash immediately with plenty of water.

#### **Asbestos**

This stove contains no asbestos. If there is a possibility of disturbing any asbestos in the course of installation then please seek specialist guidance and use appropriate protective equipment.

#### **Metal Parts**

When installing or servicing this stove care should be taken to avoid the possibility of personal injury.

#### **“IMPORTANT WARNING”**

This stove must not be installed into a chimney that serves any other heating appliance.

The complete installation must be done in accordance with current Standards and Local Codes. It should be noted that the requirements and these publications may be superseded during the life of this manual.

*Please refer to the current standards, BS EN 15287-1:2007 Design, Installation and Commissioning of chimneys. BS EN 14336:2004: Heating Systems in Buildings. Installation & Commissioning of Water Based Heating Systems. BS EN 12828: 2003; Heating Systems in Buildings. Design of Water Based Heating Systems. BS EN 12831: 2003; Heating Systems in Buildings. method for calculation of the design heat load.*

Your Stanley stove is supplied with the following items:

- Glove
- Hob Blanking Plate

### FLUES

Flues should be vertical wherever possible and where a bend is necessary, it should not make an angle of more than 45° with the vertical. Horizontal flue runs should be avoided except in the case of a back outlet from the appliance, when the length of the horizontal section should not exceed 150mm.

In order to minimise flue resistance and to make sweeping easier it is recommended to use 2 x 45° bends rather than a 90° bend.

### CHIMNEY

**Do not connect to a chimney serving another appliance.**

The stove is a radiant room heater and must be connected to a chimney of the proper size and type.

The chimney must have a cross-sectional area of at least 30 square inches 19350sq. mm or a diameter of at least 6” (150mm). It is best to connect to a chimney of the same size, as connection to a larger size may result in a somewhat less draught.

A flue that has proved to be unsatisfactory, particularly with regard to down draught should not be used for venting this appliance until it has been examined and any faults corrected. An existing masonry chimney should be inspected and if necessary repaired by a competent mason or relined using an approved lining system.

All register plates, restrictor plates, damper etc., which could obstruct the flue at a future date should be removed before connecting this appliance.

If connecting to an existing chimney with a flue diameter of more than 8" it is recommended to line the flue using a suitable stainless steel flue liner.

Where a masonry chimney is not available a proprietary type of 6"/150mm - twin wall, fully insulated pipe may be used. The pipe must terminate at a point not lower than the main ridge of adjacent outside obstructions. With such installation, access to the chimney must be provided for cleaning purposes.

A chimney / flue termination must be located to minimise wind effects, a basic guide is that the distance from the termination to the roof should be at least 2300mm when measured horizontally and at least 1000mm when measured vertically, (see Fig.1). In circumstances where there are adjoining buildings/ structures/ roof openings there are additional requirements, please refer to building regulations part J.

Fig.1

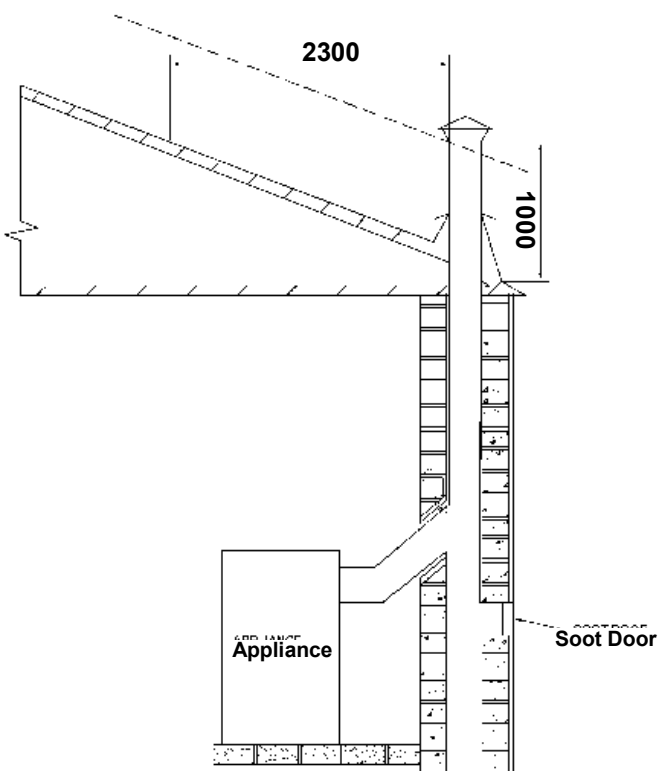

**FLUE EXIT (TOP & REAR)**

The stove is designed to allow the chimney to be cleaned through the stove. If the chimney cannot be cleaned through the stove it is necessary to provide a soot box/ access door in the flue for cleaning. See Fig.2 for recommended locations. Fit it to the stove as shown in Fig.2. The stove has one flue exit with separate spits for top outlet and rear outlet, it comes configured for a Top Outlet Flue connection and can be changed for a Back Outlet Flue connection using the following procedure:

1. Remove the outer rear flue blanking plate by cutting off the location tabs - see Fig 3.
2. Remove the flue spigot from inside the stove by removing the four bolts - see Fig 4, the top baffle will need to be removed first this can be removed by sliding it forward then lift one edge, slide the baffle to that side until opposite edge can drop into the firebox.
3. Fit the back outlet flue spigot which is supplied packed in the firebox .
4. Fit the flue blanking plate to the top outlet.

Fig.2

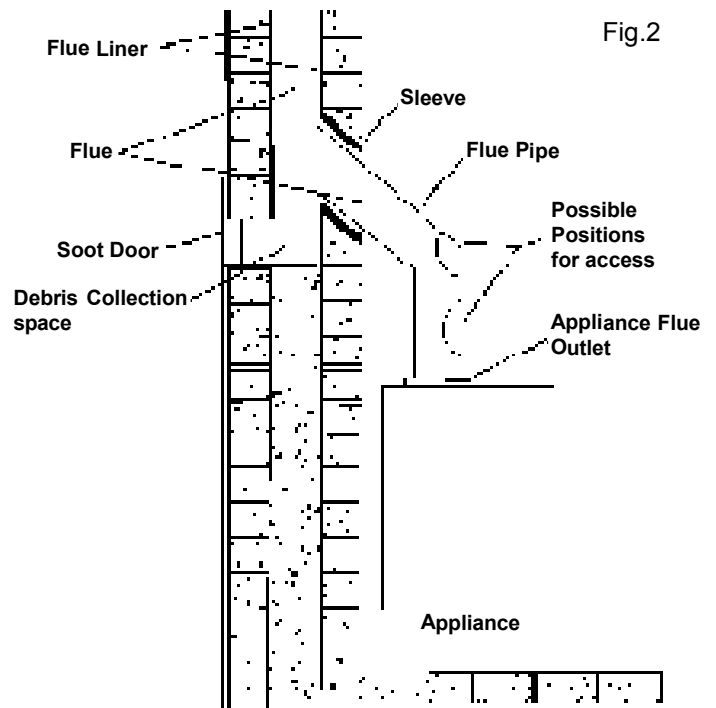
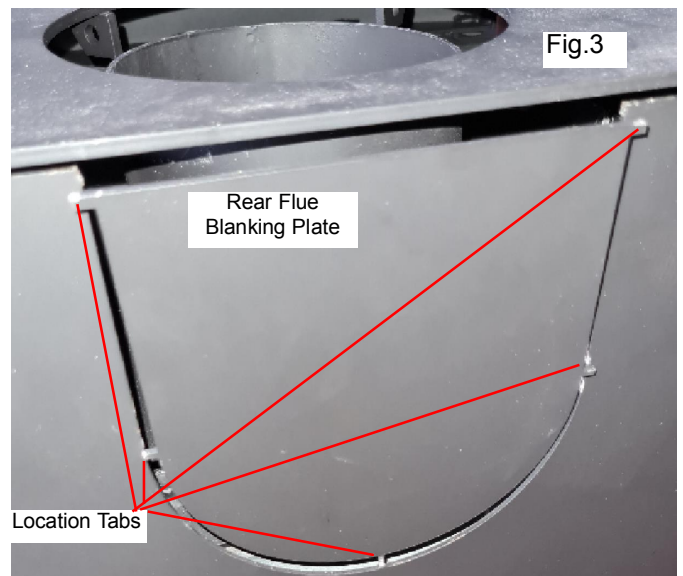

Fig.3



## VENTILATION & COMBUSTION AIR REQUIREMENTS

It is imperative that there is sufficient air supply to the stove in order to support correct combustion. The air supply to this appliance must comply with current Building Regulations Part J, Heat Providing Appliances. If another appliance is fitted in an adjacent room it will be necessary to calculate an additional air supply. The minimum effective air requirement for this appliance is 16.5cm<sup>2</sup>. When calculating combustion air requirements for this appliance use the following equation:

550mm<sup>2</sup> per each kw of rated output above 5kw should be provided, where a flue draught stabiliser is used the total free area shall be increased by 300mm<sup>2</sup> for each kw of rated output.

### NOTE:

There must not be an extractor fan fitted in the same room as the stove as this can cause the stove to emit smoke and fumes into the room.

All materials used in the manufacture of air vents should be such that the vent is dimensionally stable, corrosion resistant, and no provision for closure. The effective free area of any vent should be ascertained before installation. The effect of any grills should be allowed for when determining the effective free area of any vent. Air vents should be positioned so that they are not liable to blockage. Air vents direct to the outside of the building should be located so that any air current produced will not pass through normally occupied areas of the room.

An air vent outside the building should not be located less than the dimensions specified within the Building Regulations and B.S. 8303: Part 1 from any part of any flue terminal. These air vents must also be satisfactorily fire proofed as per Building Regulations and B.S. 8303: Part 1. Air vents in internal walls should not communicate with bedrooms, bedsits, toilets, bathrooms or rooms containing a shower. Air vents traversing cavity walls should include a continuous duct across the cavity. The duct should be installed in such a manner as not to impair the weather resistance of the cavity.

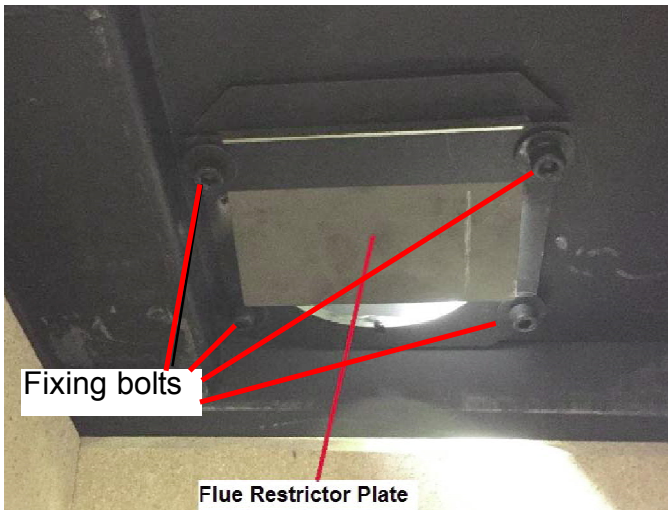

### DOWN DRAUGHTS

However well designed constructed and positioned, the satisfactory performance of the flue can be adversely affected by down draught caused by nearby hills, adjacent tall buildings or trees. These can deflect wind to blow directly down the flue or create a zone of low pressure over the terminal.

A suitable terminal or cowl will usually effectively combat direct down blow but no cowl is likely to prevent down draught due to a low pressure zone. (See Fig.6).

Fig.6

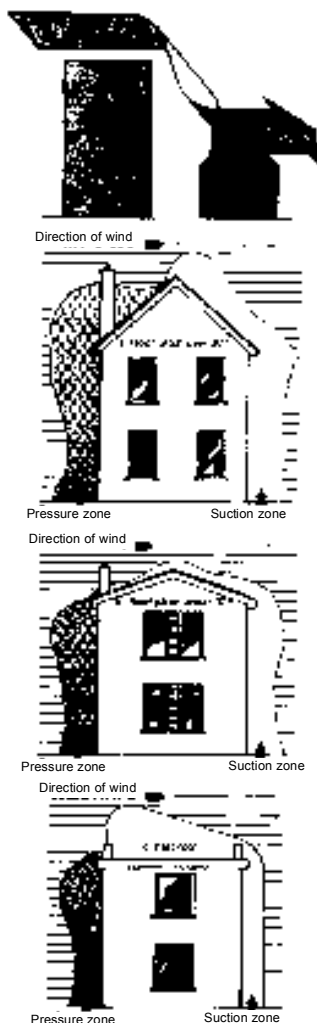



Joints between air vents and outside walls should be sealed to prevent the ingress of moisture. Existing air vents should be of the correct size and unobstructed for the appliance in use.

If there is an extraction fan fitted in adjacent rooms where this appliance is fitted, additional air vents may be required to alleviate the possibility of spillage of products of combustion from the appliance/flue while the fan is in operation. Refer to B.S. 8303 Part 1.

Where such an installation exists, a test for spillage should be made with the fan or fans and other appliances using air in operation at full rate, (i.e. extraction fans, tumble dryers) with all external doors and windows closed.

If spillage occurs following the above operation, an additional air vent of sufficient size to prevent this occurrence should be installed.

### ***Especially Airtight Properties:-***

If the stove is being fitted in a property where the design air permeability is less than  $5\text{m}^3 / (\text{h.m}^2)$  (normally newer properties built from 2006), then a permanent ventilation must be fitted to provide  $550\text{mm}^2$  of ventilation for each kW of rated output. If a draught stabiliser is also fitted then the requirement is  $850\text{mm}^2$  per kW of rated output.

## **EXTERNAL DUCTED AIR**

Where required the combustion air supply can be ducted from outside.

Outside air kit optional extra part code AOSAVKIT.

It is recommended to bring the air supply for the stove into the house using a 4" pipe. Where the pipe meets the outside wall make sure a vent cover is fitted properly to ensure no rodents can enter via the vent pipe.

The vent pipe should be located to prevent the ingress of moisture and in a location where it will not get blocked with leaves or any other debris. As wind effects can create suction and pressure zones of opposite sides of the dwelling it is recommended to run the air vent from opposite poles (North, South, East & West) of the dwelling and tee off for the air supply to the stove. This should negate the effect of suction and pressure zones. See Fig.7

*'HETAS product approval covers this appliance when installed in accordance with the manufacturer's instructions and relevant standards. As there is currently no standard for Ducted Combustion Air Supply this does not fall within the remit for HETAS product approval. Responsibility for the specification of this and for appropriate manufacturer's instructions is carried by the appliance manufacturer, as allowed for under the Building Regulations.'*

Fig.7

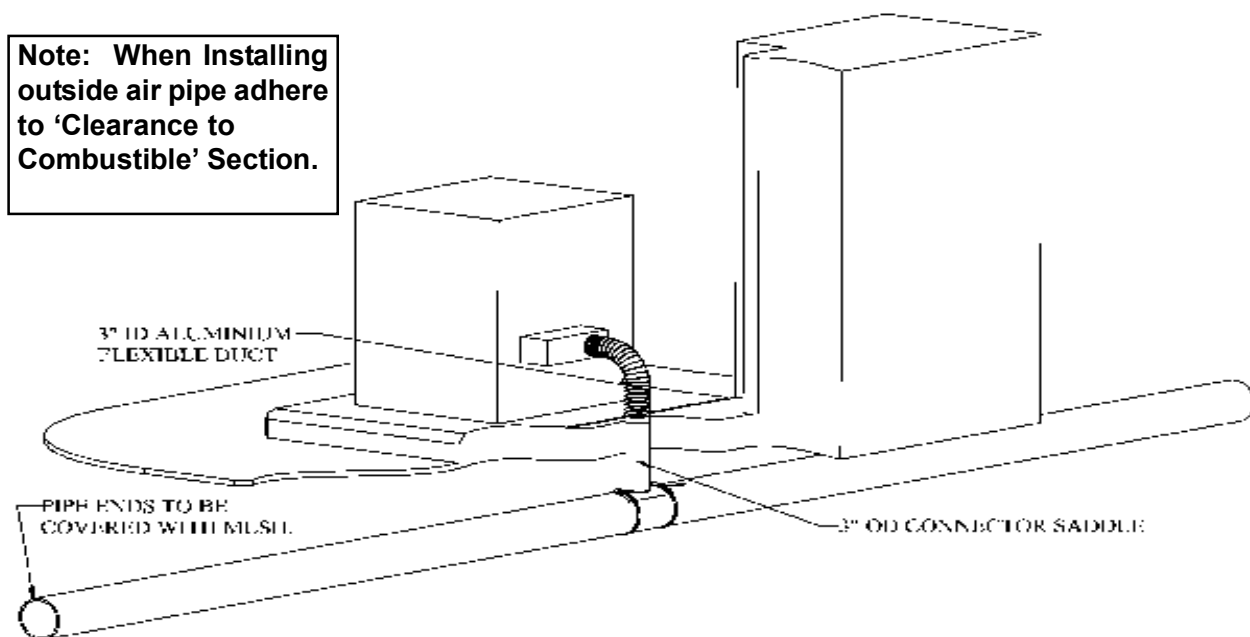

## HEAT RECOVERY VENTILATION

Where a stove is to be installed in a dwelling with *Heat Recovery Ventilation* (HRV) a number of precautionary measures must be undertaken:

Where the product is to be installed with a Mechanical Ventilation, the stove must be connected to an external air supply, The ductwork for the external air supply must be no longer than 6 metres and the air inlet terminal to the ductwork must have a cross sectional area of at least 80cm<sup>2</sup>.

## LOCATION

There are several conditions to be considered in selecting a location for your Stanley Stove.

- Position in the area to be heated, central locations are usually best.
- Allowances for proper clearances to combustibles.
- Allowances for proper clearances for maintenance work.

## CLEARANCES TO COMBUSTIBLES

**Maintain at least the following clearances to all combustible material:**

From the Front	800mm
From the Back	300mm
From the Sides	300mm
Brick wall minimum clearance, but allow access for controls and servicing.	

## FLOOR PROTECTION

When installing this heater on a combustible floor, a floor protector consisting of a layer of non combustible material at least 310mm thick covered with "1/8 sheet metal" is required to cover the area under the heater and extend at least 460mm at the front, 200mm to the sides & the rear. This will provide protection from sparks and embers which may fall out from the door when stoking on refuelling. See Fig.8.

Fig.8

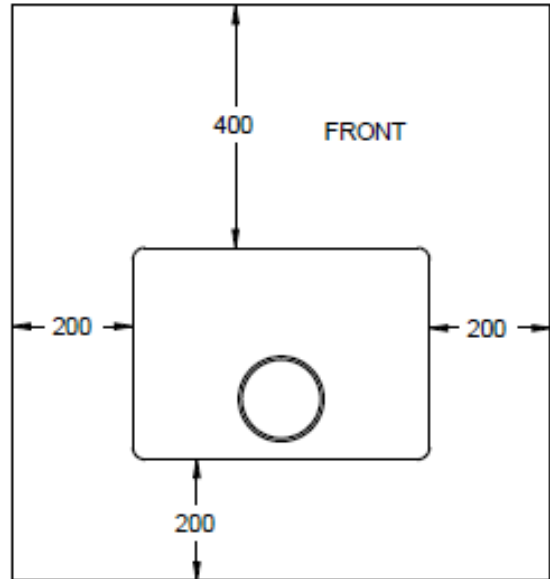

## STOVE DIMENSIONS

Fig.9

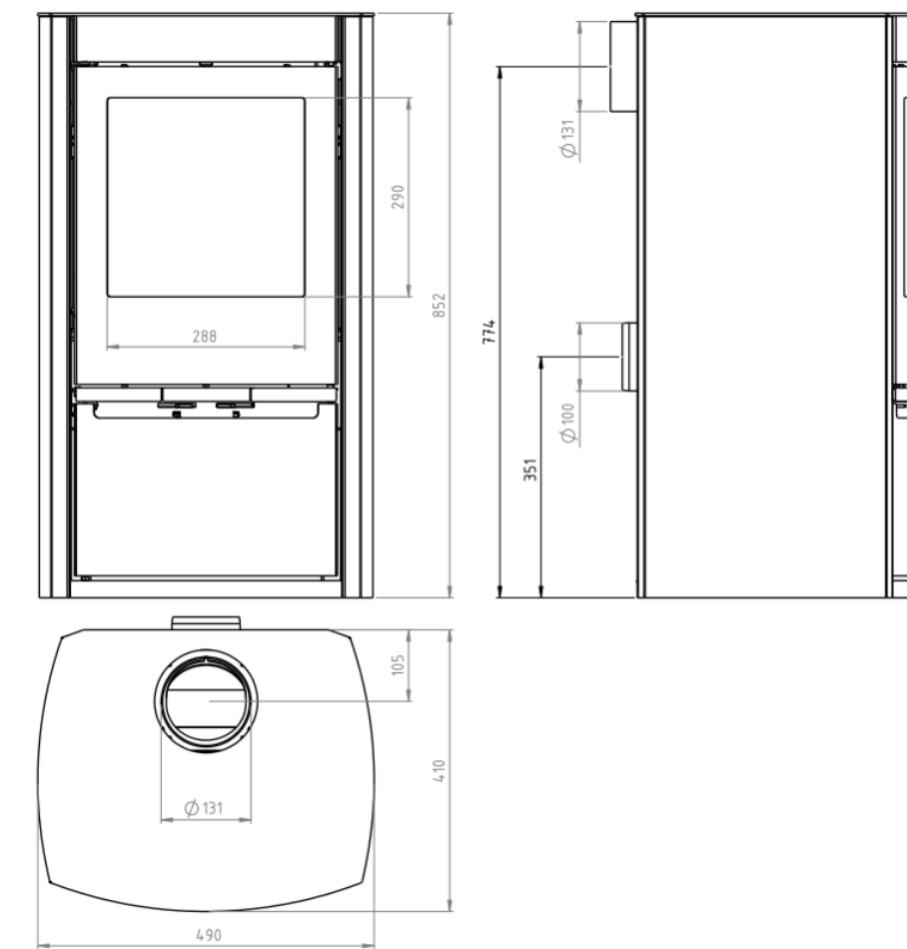

**WARNING: DO NOT OBSTRUCT PRIMARY AIR SUPPLY TO THE STOVE**

**Note:** Dimensions stated are in millimetres unless otherwise stated and may be subject to a slight +/- variation.

### COMMISSIONING AND HANDOVER

On completion of the installation allow a suitable period of time for any fire cement and mortar to dry out, when a small fire may be lit and checked to ensure the smoke and fumes are taken from the stove up the chimney and emitted safely to the atmosphere. **Do not run at full output for at least 24 hours.**

Ensure that the operating instructions for the stove are left with the customer. Ensure to advise the customer on the correct use of the appliance with the fuels likely to be used on the stove and warn them to use only the recommended fuels for the stove.

Advise the user what to do should smoke or fumes be emitted from the stove. The customer should be warned to use a fireguard to BS 8432: 2010 in the presence of children, aged and/or infirm persons.

### OPERATION

Check that all dampers and catches are operating correctly and ensure that all flue connections are thoroughly sealed.

### AIR CONTROLS

The stove has two independent air controls (see Fig 10):

1. The primary air control lever is the right hand lever located under the fire door. Push right to open and left to close.
2. The secondary air control lever is the left hand lever located under the fire door. Push left to open and right to close..

**Note:**

The controls may become hot when the stove is in operation. Use glove provided to adjust the controls when the stove is hot.

## RECOMMENDED FUELS

All fuels should be stored under cover and kept as dry as possible prior to use.

This appliance has been tested using seasoned wood logs.

If opting to burn solid fuel, a solid fuel kit must be installed. (See Installing Solid Fuel Kit section)

Do not use fuels with a Petro-coke ingredient as this may cause the grate to overheat, causing damage. Reduced outputs will result when fuels of lower calorific values are used. Never use gasoline or gasoline type lantern fuel, kerosene, charcoal lighter fluid or similar liquids to start or freshen up a fire in this heater. Keep all such liquid well away from the heater at all times. Operate the stove only with the fuelling door closed except for re-fuelling.

This stove has obtained HETAS Ltd approval for burning natural and manufactured smokeless fuels only as detailed in recommended fuels below. HETAS Approval does not cover the use of other fuels either alone or mixed with the recommended fuels listed, nor does it cover instructions for the use of other fuels.

Fig.10

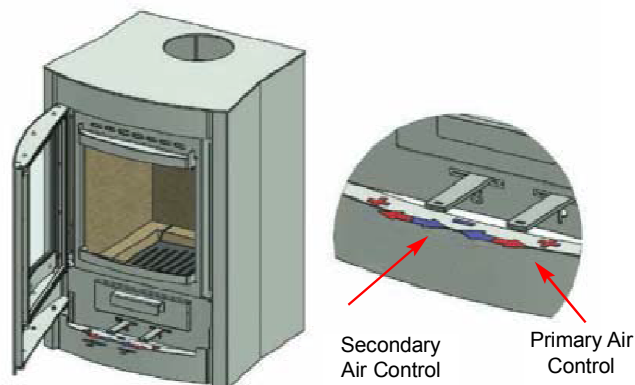

## TECHNICAL DATA

### SOLIS INSET 500

	MANUFACTURED SMOKE-LESS FUEL	WOOD
Nominal Output: (kW)	Room 5kW	Room 5kW
Typical refuelling intervals to obtain nominal outputs:	MSF 1 hour	Wood .75 hours
Mean Flue Gas Temperature °C	205	253
Flue Gas Mass Flue	4.3	4.3
Flue Outlet:	127mm	
Efficiency	81%	82%
Flue Draught:	15pa	15pa
Max Log Size	N/A	Ø100mm x 260 mm

Model	Energy Efficiency Class	Heat Output to Room	Heat Output to Water	Energy Efficiency Index	Preferred Fuel	Nominal Heat Output	Net Efficiency
Solis 500 Curve	A <sup>+</sup>	5	N/A	110	Wood	5	82

## LIGHTING

Before lighting the stove check with the installer that the installation work and commissioning checks described previously have been carried out correctly and that the chimney has been swept clean, is sound and free from any obstructions. As part of the stoves commissioning and handover the installer should demonstrate how to operate the stove correctly.

**LEAVE THE DOOR SLIGHTLY AJAR DURING THE FIRST FIRING TO PREVENT THE ROPE FROM STICKING TO THE PAINT DURING THE CURING PROCESS.**

## INSTALLING SOLID FUEL KIT - 500 MODEL

IF OPTING TO BURN SOLID FUEL, A SOLID FUEL KIT MUST BE INSTALLED.

1. Open the fire door and remove the ashpan.
2. Lift out the grate by pushing it upwards through the ash compartment.
3. Remove the base bricks (see Fig. 17).

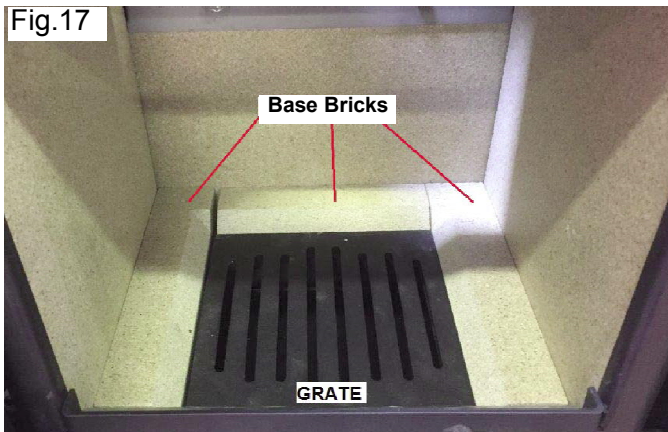

4. Refit the grate.
5. Fit the two refractory bricks as shown in fig. 19.

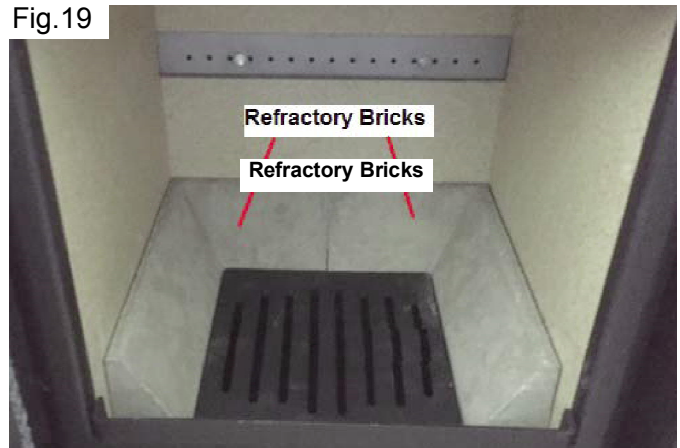

## LIGHTING THE STOVE

1. Open the fire door and open the primary air inlet by pushing the primary air control lever to the right.
2. Open the secondary air inlet by pushing the secondary air control lever to the left.
3. Cover the grate with crumpled pieces of paper and lay 10-12 pieces of kindling on top of the paper towards the back of the firebox.
4. Ignite and close the fire door.
5. When the kindling is well alight open the fire door and add more kindling of a larger size to sustain the fire. Close the fire door.
6. When a hot fire bed is established add the normal fuel.
7. When well lighted, adjust the air controls as required depending on the fuel type being used & the heat output required (see Table). Both controls should be adjusted in conjunction with each other to get the appropriate burn rate with exact settings on each control depending on the draught conditions of the chimney to which the unit is connected.
8. If there is insufficient burning material in the firebed to light a new fuel charge, excessive smoke emission can occur. Refuelling must be carried out onto a sufficient quantity of glowing embers and ash that the new fuel charge will ignite in a reasonable period. If there are too few embers in the fire bed, add suitable kindling to prevent excessive smoke.
9. The maximum amount of fuel specified in this manual should not be exceeded, overloading can cause excess smoke.

## AIR CONTROLS

Fuel	Ignition		Controlled Burn	
	Primary Air	Secondary Air	Primary Air	Secondary Air
Anthracite/ Smokeless Coal	Fully Open	Fully Closed	0-80% Open	Fully Closed
Wood/ Turf	Fully Closed	Fully Open	Fully Closed	0-80% Open

**WARNING: DO NOT LEAVE BOTH AIR CONTROLS FULLY OPEN AS THIS CAN CAUSE THE STOVE TO OVERHEAT, DAMAGING THE INTERNAL COMPONENTS.**

## REFUELLING

Before opening the door, open the primary air control fully as this will help to eliminate any smoke or fly ash resident in the combustion chamber. Add fuel to fire, close fire door and re-set the air controls to the required setting.

## SLOW BURNING

Slow burning will cause the window glass to blacken and should not be used for a long period. It should only be done after the fire has been established and been running at nominal output for a period of time. For a prolonged slow burn, fill the firebox of fuel up to a maximum height just below the top of the fire fence at the front of the door opening. Close the primary air control and the secondary air control.

## DISPOSAL OF ASHES

Your stove is provided with an ashpan which should be emptied every day. If ashes are allowed to build to grate level you could damage the grate by overheating. We recommend that you remove ashes after you have riddled the fire when the stove is thoroughly cooled. Ashes should be placed in a metal or other non-combustible container with a tight fitting lid. The closed container of ashes should be placed on a non-combustible material, pending final disposal. If ashes are buried in soil, or otherwise dumped they should be retained in the closed container until they are thoroughly cooled. Open the fire door and remove the ashpan using the glove provided. Close the fire door. When the ash is disposed of, replace the ashpan.

## MONTHLY MAINTENANCE

### *Cleaning Stove Flue Pathways*

It is recommended that the flue pathways in the stove are cleaned on a monthly basis (or less depending on the soot build-up created by the fuel being used) and the chimney cleaned annually. To access the chimney pathways, use the following procedure:

1. Remove the top baffle from the firebox by pulling it forward and lifting it up on the RHS to allow the LHS of the baffle to drop into the firebox so that it can be removed through the fire door opening.
2. Remove the Flue Restriction Plate by pulling it towards the fire door (see Fig. 12).

## CHIMNEY CLEANING

The chimney should be cleaned twice annually or if the stove is not used for a prolonged period during the summer period, it should be cleaned prior to commencement of usage. The chimney can be cleaned through the stove depending on the flue configuration and the flue liner should be cleaned in accordance with manufacturer's instructions. Always use a brush with plastic bristles that is the correct size to reach all areas of the flue.

## GLASS CLEANING

The stove glass will self-clean when there is sufficient heat generated by the burning fuel i.e. when the unit is operated at the maximum air settings. If a build-up of creosote occurs on the glass it may be due to low draft conditions, poor quality fuel or operating the stove at the minimum air settings for long periods of time. The glass should be cleaned when cool and cleaned with a non-abrasive cloth using warm soapy water. For stubborn deposits, a grade 0 steel wool can be used whilst taking care not to scratch the glass with any coal/ash deposits.

## CLEANING A MATT BLACK/ SENOTHERM STOVE

Cleaning should be done when the stove is cold by removing any dust or dirt using a dry cloth. Do not use any water on the matt black/senotherm finish as this will cause it to rust.

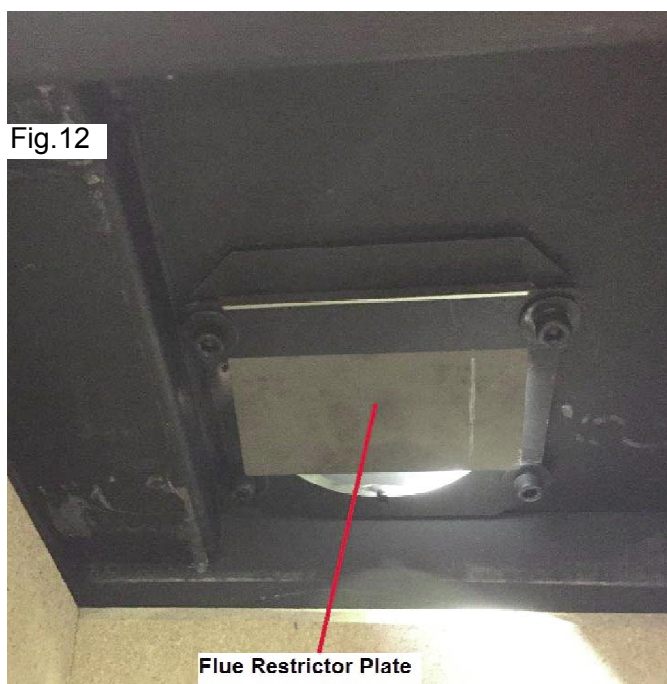

## PROLONGED PERIODS OF NON USE

If the stove is to be left unused for a prolonged period of time then it should be given a thorough clean to remove ash and unburned fuel residues. To enable a good flow of air through the appliance to reduce condensation and subsequent damage, leave the air controls fully open.

It is important that the flue connection, any appliance baffles or throat plates and the chimney are swept prior to lighting up after a prolonged shutdown period.

### WARNING NOTE:

Properly installed, operated and maintained this stove will not emit fumes into the dwelling. Occasional fumes from the de-ashing and re-fuelling may occur. However, persistent fume emission is potentially dangerous and must not be tolerated. If fume emission does persist, then the following immediate action should be taken:

- (a) Open doors and windows to ventilate room.
  - (b) Let the fire out or eject and safely dispose of fuel from the stove.
  - (c) Check for flue or chimney blockage and clean if required.
  - (d) Do not attempt to relight the fire until the cause of the fume emission has been identified and corrected. If necessary seek expert advice.
- The most common cause of fume emission is flue-way or chimney blockage. For your own safety these must be kept clean at all times.

Fig.14

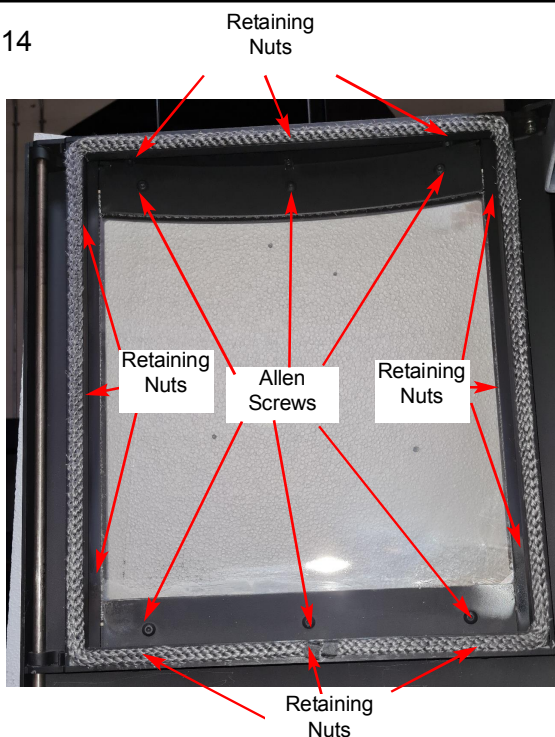

## FIRE SAFETY

To provide reasonable fire safety, the following should be given serious consideration.

1. Do not over fire the stove.
2. Over-firing will also damage the painted finish.
3. Install a smoke detector in the room.
4. A conveniently located class A fire extinguisher to contend with small fires resulting from burning embers.
5. A practical evacuation plan.
6. A plan to deal with a chimney fire as follows:-
  - (a) Notify the fire department.
  - (b) Prepare occupants for immediate evacuation.
  - (c) Close all openings into the stove.
  - (d) While awaiting the fire department watch for ignition to adjacent combustibles from overheated flue pipe or from embers or sparks from the chimney.

## GLASS REPLACEMENT

- (a) Open the fire door fully.
- (b) Remove the rope seal from the door.
- (c) Remove the rope channel brackets by loosening the nuts (see Fig 14).
- (d) Remove the top & bottom brackets by removing the allen screws (see Fig 14)
- (e) Before fitting the new glass, check the glass sealing on the door frame and replace if necessary.
- (f) Refit the brackets & refit the rope seal using an appropriate fire cement.

## CO ALARM

The fitting of CO Alarms in the same room as the appliance is a compulsory requirement under current Building Regulations. For ROI an additional CO Alarm must be fitted either inside each bedroom or within 5 metres of the bedroom door, refer to Building Regulations Part J. Further guidance on the installation of a carbon monoxide alarm is available in BS EN 50292:2002 and from the alarm manufacturers instructions.

**Provision of an alarm must not be considered a substitute for either installing the appliance correctly or ensuring regular servicing and maintenance of the appliance and chimney system.**

### WARNING:-

If the CO Alarm sounds unexpectedly:-

1. Open Doors and windows to ventilate the room and then leave the premises.
2. Let the fire go out.

# STANLEY SOLIS 500 CURVE EXPLODED VIEW

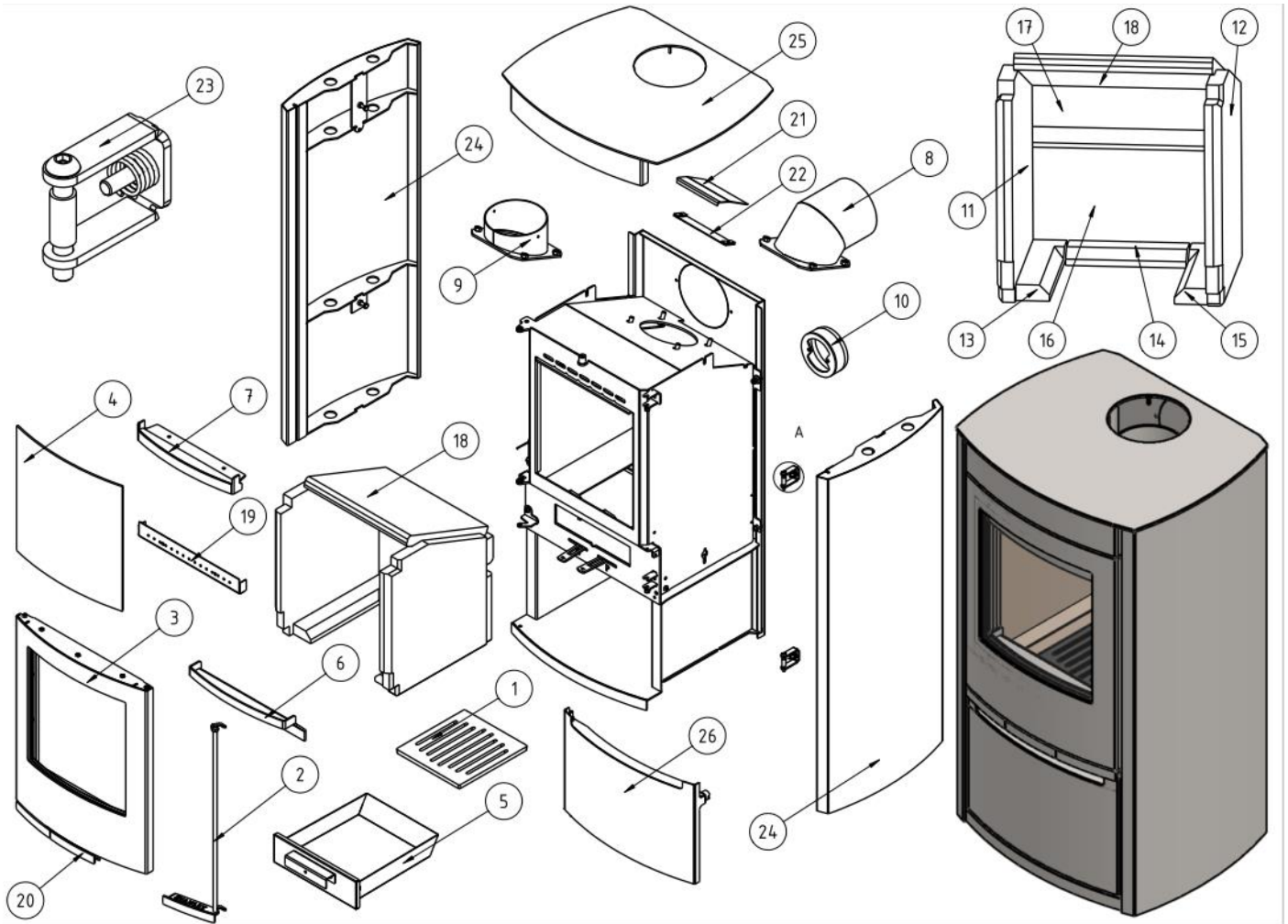

Item No	Item code	Description	Item No	Item code	Description
	10000962	Door Gasket (Ø12 mm)	13	093-30-001	LH Base Brick
	10000972	Door Glass Gasket (Ø6 mm)	14	093-30-003	Rear Base Brick
1	30006478	Grate	15	093-30-002	RH Base Brick
2	30012346	Door Locking System	16	093-30-004	Bottom Back Brick
3	30012345	Door Subassembly	17	093-30-005	Top Back Brick
4	30008115	Door Glass	18	093-30-006	Top Baffle
5	30008116	Ash Pan	19	30008118	Bottom Back Brick Fixing Bracket
6	30008117	Standing rostr	20	30012344	Chrome Door Trim
7	30008119	Secondary air restrictor	21	30008817	Flue Restrictor Plate
8	30000260	flue connection band ø131 mm	22	30008818	Flue Restrictor Plate Fixing Bracket
9	30008823	Flue Spigot ø131 mm	23	30008819	Spring loaded locking mechanism
10	30008124	OSA Connection	24	30012341	steel sides
11- 18	30006443	lining set - bricks set	25	30012342	top plate
11	093-30-008	LH Side Brick -	26	30008123	log door ( Optional Extra)
12	093-30-007	RH Side Brick -			

**Manufactured for**  
**Waterford Stanley Ltd.,**  
 Unit 401-403, IDA Industrial Estate,  
 Cork Road, Waterford, Ireland.  
[www.waterfordstanley.com](http://www.waterfordstanley.com)

