



**AGA GAS
MARK 2 BURNER
(CONVERSION)**

***FITTING
INSTRUCTIONS***

Remember, when replacing a part on this appliance, use only spare parts that you can be assured conform to the safety and performance specification that we require. Do not use reconditioned or copy parts that have not been clearly authorised by Aga.

PLEASE READ THESE INSTRUCTIONS BEFORE FITTING THIS BURNER

For use in GB/IE/USA/CANADA

08/08 EINS 515478

TECHNICAL DATA

AGA GAS MARK 1 BURNER (CONVERSION)

NATURAL G20

MAXIMUM HEAT INPUT	5 kW
Thermostat By-Pass Size	110
Main Burner Injector	400
Pilot Injector	4212
Inlet Pressure (EU COUNTRIES ONLY)	20 mbar
Burner Pressure	10 mbar (4" w.g.)

PROPANE G31

MAXIMUM HEAT INPUT	5 kW (357 g/h)
Thermostat By-Pass Size	70
Main Burner Injector	170
Pilot Injector	4209
Inlet Pressure (EU COUNTRIES ONLY)	37 mbar
Burner Pressure	25 mbar (10" w.g.)

NOTE: ON 4-OVEN MODELS WITH BOILER (GEB), IT MAY BE NECESSARY TO INCREASE THE BURNER PRESSURE SLIGHTLY (12 mbar).

NOTE: Maximum inlet operating pressure for the multi-function gas valve is 50 mbar.

HOW TO FIT NEW BURNER

1. Isolate gas supply to the cooker.
2. Remove existing burner assembly taking care not to damage gas inlet pipe.
3. Fit new gas cock to inlet pipe ensuring the on/off tap faces the front
4. Fit new burner assembly (see fig 1). Attach burner to burner housing using 4 screws and 4 washers. Tighten coupling nut on top of gas cock.
5. Feed gas valve sensing probe and capillary through guide tube in top of burner housing.
6. From inside roasting oven fit sensing probe to bracket and fix bracket to top of roasting oven.
7. Make sure the gas cock is in the ON position (see fig 2). Turn on gas supply to Aga. Check for gas tightness.

IMPORTANT NOTE: Attach new lighting instructions label (supplied) onto the existing instruction plate on the outer burner door. (Ensure the lighting instructions depict the graphics printed on gas valve control knob).

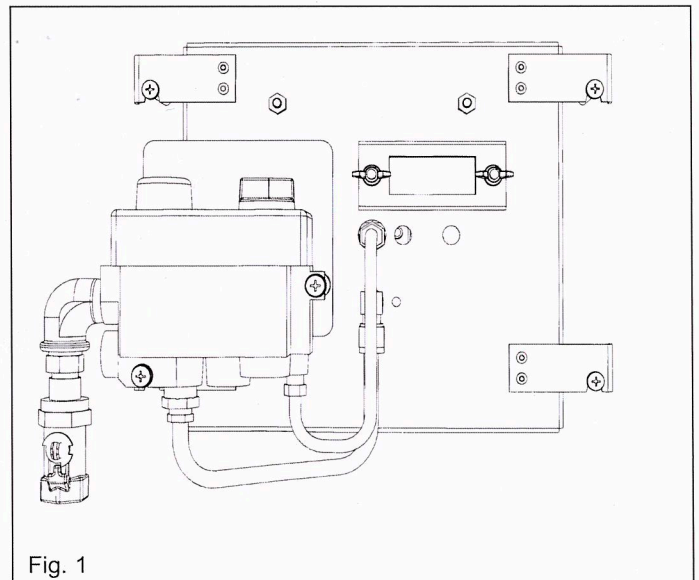
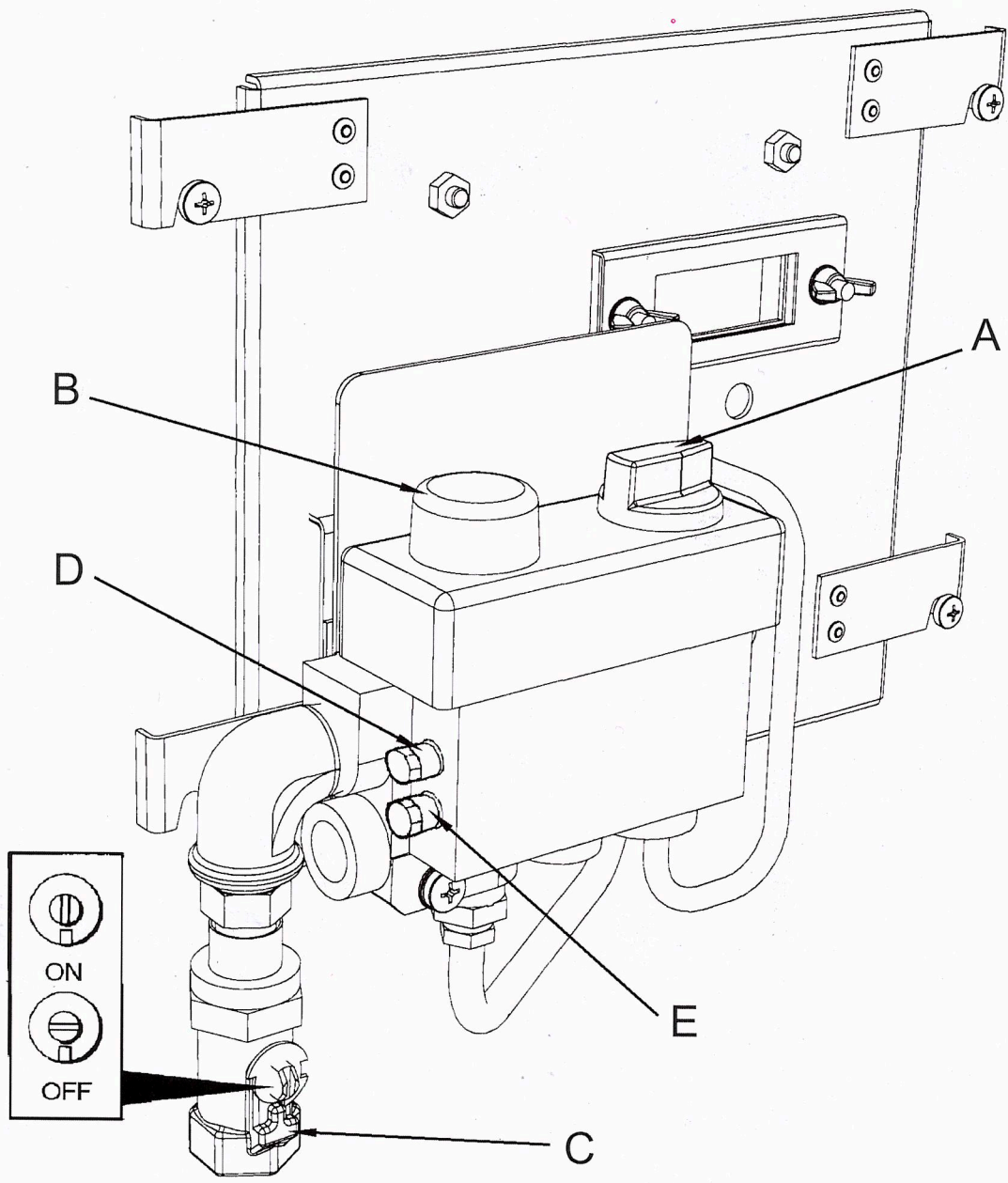

Fig. 1



- A - ON/OFF CONTROL KNOB
- B - TEMPERATURE CONTROL KNOB
- C - GAS COCK
- D - INLET PRESSURE TEST NIPPLE
- E - BURNER PRESSURE TEST NIPPLE
- F - PRESSURE REGULATOR ADJUSTMENT

NOTE: To adjust burner pressure. Remove plastic cover (single screw) and turn screw clockwise to increase burner pressure.

Fig. 2

DESN 513171 MOD

COMMISSIONING

FOR CONTROL KNOB 'B' WITH NUMBERS 1-7. (SEE PAGE 6 FOR KNOB 'B' WITH GREEN BAND)

CAUTION: BEFORE LIGHTING: ENSURE KNOB (A) IS IN THE OFF POSITION (SEE FIG, 4). ALSO ENSURE GAS SUPPLY TO COOKER IS ON, AND THE GAS SERVICE COCK (C) IS IN THE ON POSITION (SEE FIG, 2).

LIGHTING PROCEDURE SEE FIGS. 4 - 8

1. The main burner gas flow is set with the 'temperature knob' (B) (See Fig. 3). Position '1' is the minimum and position '7' is the maximum temperature setting. First, ensure knob (B) is turned fully clockwise to position '1'.
2. Turn 'ON/OFF' knob (A) slightly anti-clockwise towards the IGNITION position () until reaching stop, press down and hold for 5 seconds (gas flows only to the pilot burner). (See Fig. 5).
3. Continue pressing down knob (A) while turning further counter-clockwise to the PILOT position (this activates the piezo), continue to hold down for 10 seconds after pilot burner has been lit. (If the pilot does not light, steps 2 and 3 can be repeated). (See Fig. 6).
4. Upon lighting, release knob and turn further anti-clockwise to the 'ON' position (large flame symbol) (See Fig. 7). Pilot gas flows and mains gas flows according to the temperature setting (knob B).
5. Turn the temperature knob (B) slightly anti-clockwise to position '2' (LOW FIRE position). Leave in the low fire position for at least 30 minutes (See Fig. 8A).

NOTE: 'LOW FIRE' may be between 1 and 2. Turn knob until SMALL FLAME is observed through viewing window.

6. After 30 minutes rotate control knob (B) anti-clockwise to between positions 5 and 7 for normal running (See Fig. 8B).

NOTE: After several hours the temperature of the cooker can be monitored by the heat indicator. Setting 5 to 7 should bring the indicator to the black line position. It may be necessary to adjust the control knob slightly (between 5 and 7) to achieve this. When the cooker is lit from cold moisture may form on the enamel which should be wiped off to prevent staining.

IF THE FLAME HAS EXTINGUISHED FOR WHATEVER REASON, WAIT THREE MINUTES (MINIMUM) BEFORE RELIGHTING.

7. Check the inlet gas pressure is as indicated in the table marked 'Technical Data', as follows (See Fig. 2):-
 - (a) Turn knob (A) to the OFF position (Fig. 4). Unscrew the inlet pressure test nipple plug (D) and fit manometer. Light the burner, turn knob (A)

to the ON position (Fig. 7) and knob (B) between 5 and 7 (Fig. 8B).

- (b) Check inlet pressure correctly corresponds to the table marked 'Technical Data'.
- (c) Check that the gas pressure is unaffected when other gas appliances are used.
- (d) Turn knob (A) to OFF position. Remove the pressure gauge and replace test nipple plug (screw plug back in, but take care not to overtighten).
- (e) Relight burner as steps 1-6, and check pressure test nipple for gas tightness.

8. Check burner pressure as follows:-

Repeat instruction 7 on completely cold cooker with the pressure gauge fitted to the burner pressure test nipple (E) (See Fig. 2). Check that the burner pressure correctly corresponds with the table marked 'TECHNICAL DATA' (page 2)

TO EXTINGUISH THE BURNER

1. Turn ON/OFF knob (A) clockwise until reaching stop (PILOT) position.
2. Press down slightly and continue turning clockwise from pilot position to the OFF position (See Fig. 4).

When the thermocouple has cooled sufficiently, pilot lighting procedure may be repeated.

INSTRUCTIONS

Hand these instructions to the User for retention, and instruct in the safe operation of the appliance.

Finally advise the User, that for continued efficient and safe operation of the appliance, it is important that adequate servicing is carried out at regular intervals recommended by the Aga Specialist or local gas region.

BURNER CONTROLS

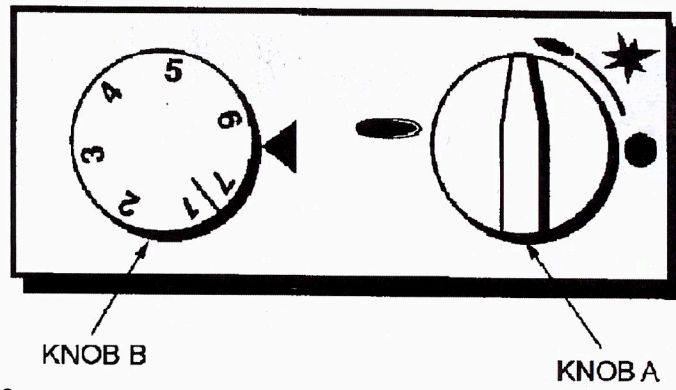
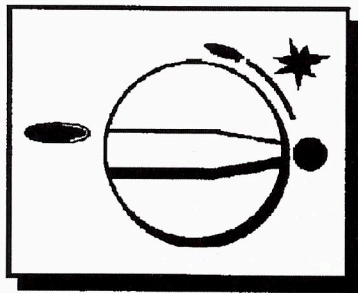
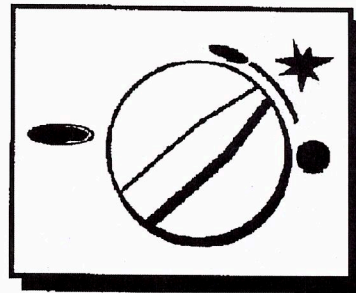

FIG. 3



OFF POSITION

FIG. 4



IGNITION POSITION

FIG. 5

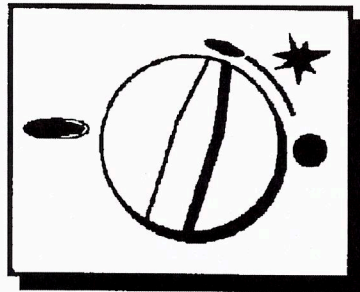

PILOT POSITION

FIG. 6

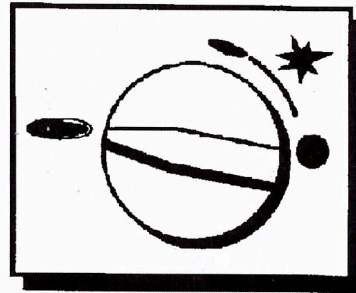

ON POSITION

FIG. 7

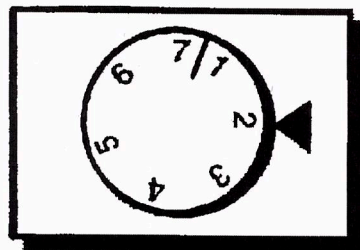

LOW FIRE
*(SEE NOTE)

FIG. 8A

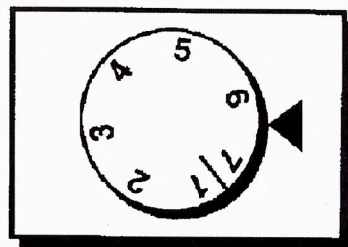

NORMAL RUNNING

FIG. 8B

NOTE: LOW FIRE may be between 1 and 2 on knob

COMMISSIONING

FOR CONTROL KNOB 'B' WITH GREEN BAND GRAPHICS.

(SEE PAGE 4 FOR KNOB 'B' WITH NUMBERS)

CAUTION: BEFORE LIGHTING: ENSURE KNOB (A) IS IN THE OFF POSITION (SEE FIG. 10). ALSO ENSURE GAS SUPPLY TO COOKER IS ON, AND THE GAS SERVICE COCK (C) IS IN THE ON POSITION (SEE FIG. 2).

LIGHTING PROCEDURE - SEE FIGS. 9 - 15

1. The main burner gas flow is set with the 'temperature knob' (B). First ensure both knobs are turned fully clockwise. Knob (A) to the OFF position and knob (B) to the minimum setting (See Fig. 9).
2. Turn 'ON/OFF' knob (A) slightly anti-clockwise towards the IGNITION position () until reaching stop, press down and hold for 5 seconds (gas flows only to the pilot burner. (See Fig. 11).
3. Continue pressing down knob (A) while turning further counter-clockwise to the PILOT position (this activates the piezo), continue to hold down for 10 seconds after pilot burner has been lit. (If the pilot does not light, steps 2 and 3 can be repeated). (See Fig. 12).
4. Upon lighting, release knob and turn further anti-clockwise to the 'ON' position (large flame symbol) (See Fig. 13). Pilot gas flows and mains gas flows according to the temperature setting (knob B).
5. Turn the temperature knob (B) slightly anti-clockwise into the white band (LOW FIRE position). Leave in the low fire position for at least 30 minutes (See Fig. 14).

NOTE: 'LOW FIRE' position is attained by turning knob (B) gradually into the white band until SMALL FLAME is observed through viewing window.

6. After 30 minutes rotate control knob (B) anti-clockwise to mid-position of the green band for normal running (See Fig. 15).

NOTE: After several hours the temperature of the cooker can be monitored by the heat indicator, Setting mid-position in green band should bring the indicator to the black line position. It may be necessary to adjust the control knob (in the green band) to achieve this. When the cooker is lit from cold, moisture may form on the enamel which should be wiped off to prevent staining.

IF THE FLAME HAS EXTINGUISHED FOR WHATEVER REASON, WAIT THREE MINUTES (MINIMUM) BEFORE RE-LIGHTING.

7. Check the inlet gas pressure is as indicated in the table marked 'Technical Data' as follows (See Fig. 2):-

- (a) Turn knob (A) to the OFF position (Fig. 10). Unscrew the inlet pressure test nipple plug (D) and fit manometer. Light the burner, turn knob (A) to the ON position (Fig. 13) and knob (B) in the green band (Fig. 15).
- (b) Check inlet pressure correctly corresponds to the table marked 'Technical Data'.
- (c) Check that the gas pressure is unaffected when other gas appliances are used.
- (d) Turn knob (A) to the OFF position. Remove the pressure gauge and replace test nipple plug (screw plug back in, but take care not to overtighten).
- (e) Relight the burner as steps 1-6, and check pressure test nipple for gas tightness.

8. Check burner pressure as follows:-

Repeat instruction 7 on completely cold cooker with the pressure gauge fitted to the burner pressure test nipple (E) (See Fig. 2). Check that the burner pressure correctly corresponds with the table marked 'TECHNICAL DATA' (page 2).

TO EXTINGUISH THE BURNER

1. Turn 'ON/OFF' knob (A) clockwise until reaching stop (PILOT) position.
2. Press down slightly and continue turning clockwise from pilot position to the OFF position (See Fig. 10).

When the thermocouple has cooled sufficiently, pilot lighting procedure may be repeated.

INSTRUCTIONS

Hand these instructions to the User for retention, and instruct in the safe operation of the appliance.

Finally advise the User, that for continued efficient and safe operation of the appliance, it is important that adequate servicing is carried out at regular intervals recommended by the Aga Specialist or local gas region.

BURNER CONTROLS

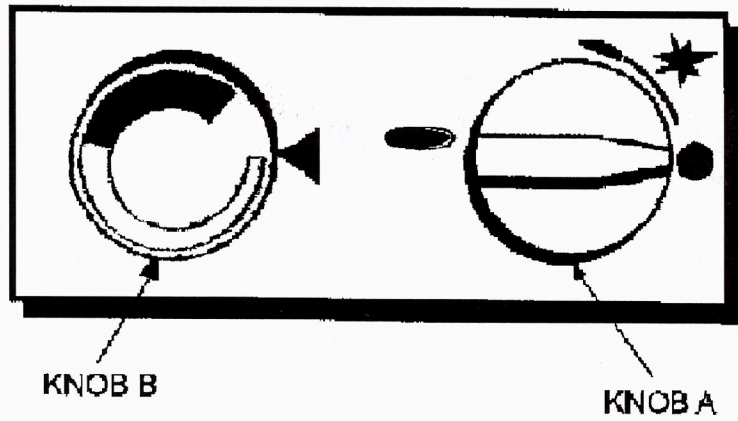
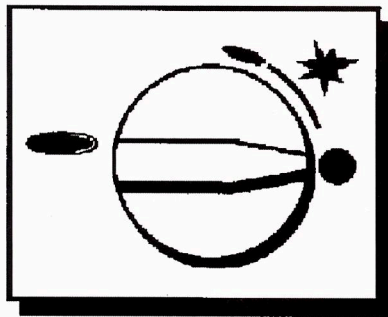
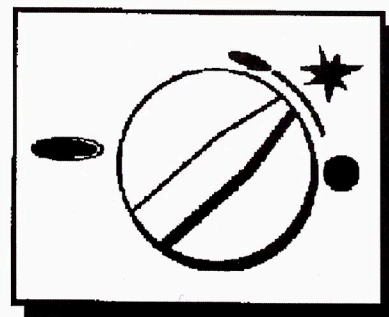

FIG. 9



OFF POSITION

FIG. 10



IGNITION POSITION

FIG. 11

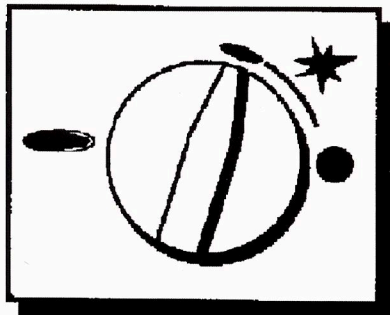

PILOT POSITION

FIG. 12

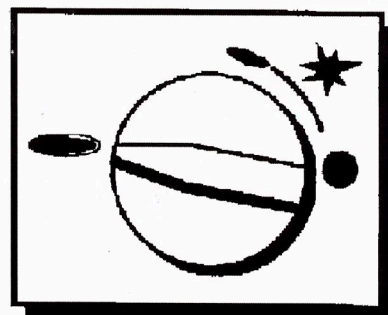

ON POSITION

FIG. 13

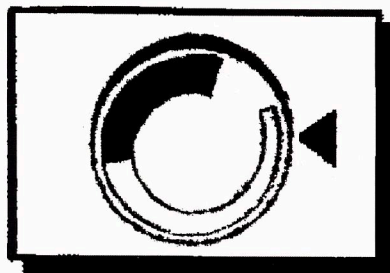

LOW FIRE

FIG. 14

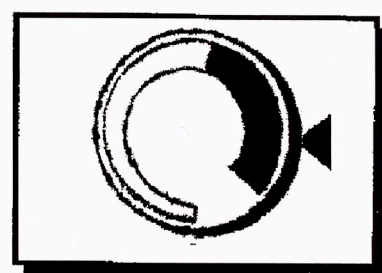

NORMAL RUNNING

FIG. 15

**For further advice or information contact
your local Aga Specialist**

With Aga's policy of continuous product improvement, the Company reserves the right to change specifications and make modifications to the appliance described and illustrated at any time.



Manufactured by
Aga
Station Road
Ketley Telford
Shropshire TF1 5AQ
England

www.aga-web.co.uk
www.agacookshop.co.uk
www.agalinks.com